

Capítulo 19 (Flower) Flor

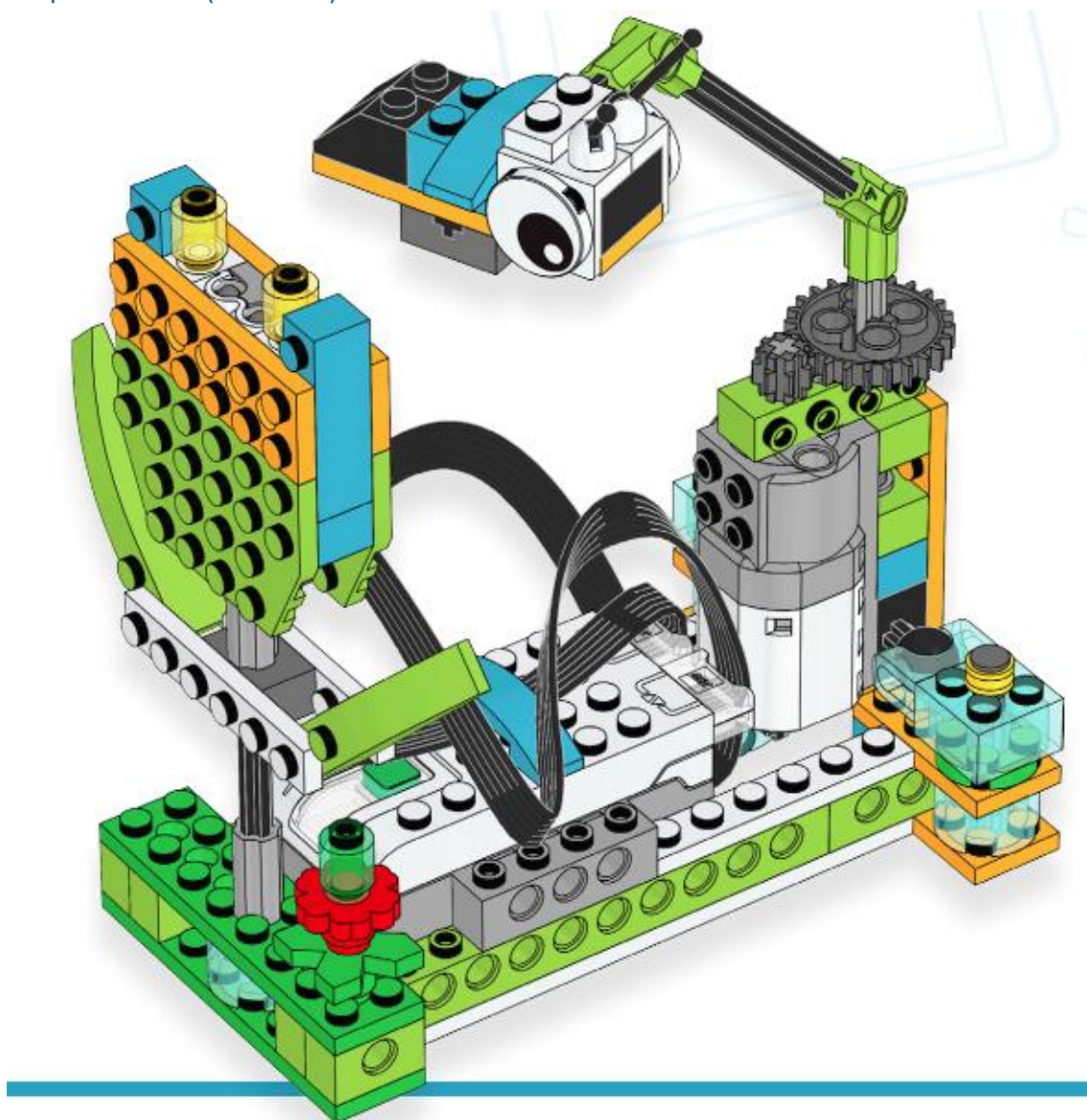

Para la realización de este capítulo solo hace falta un Kit.

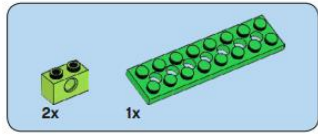

1

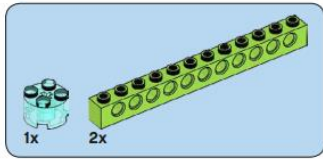
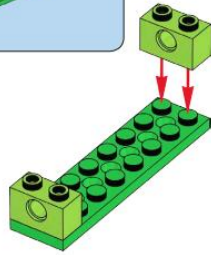

2

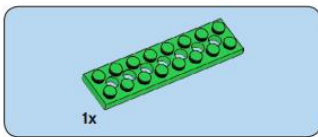
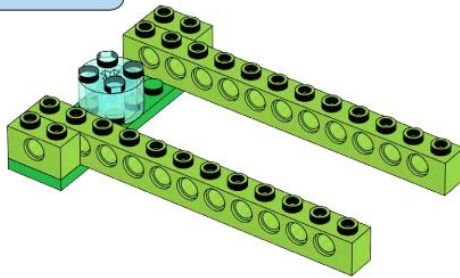

3

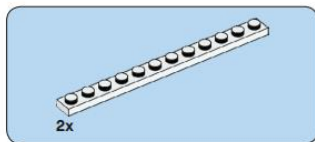
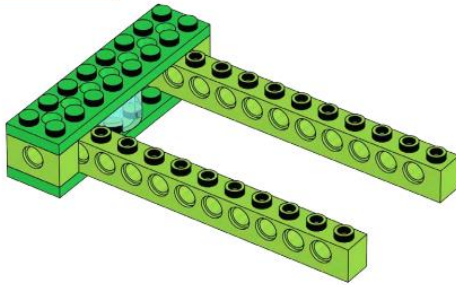

4

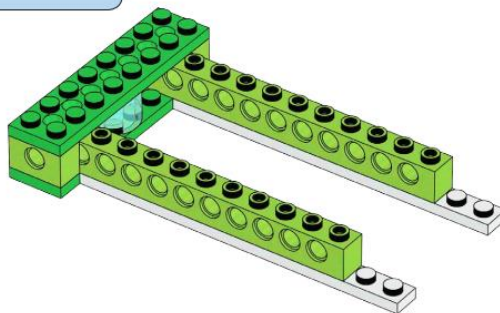

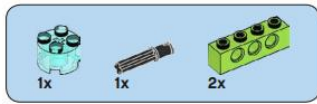

5

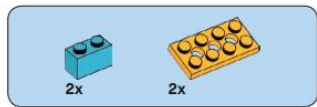
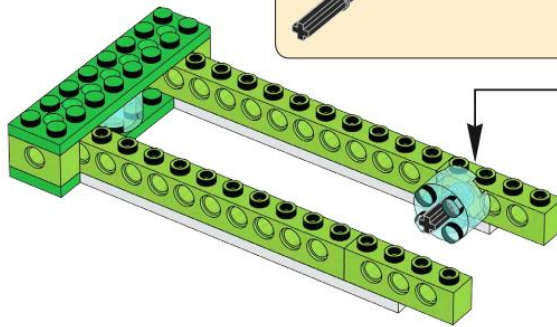
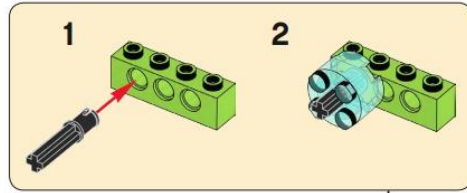

6

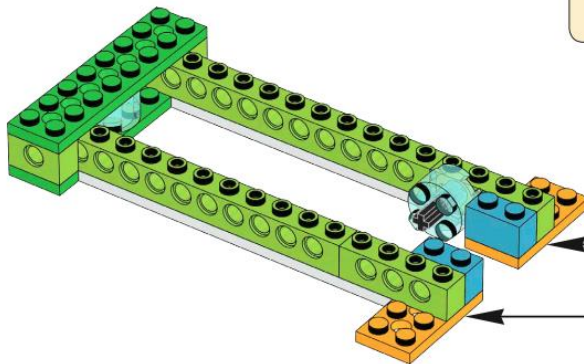
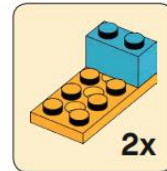

7

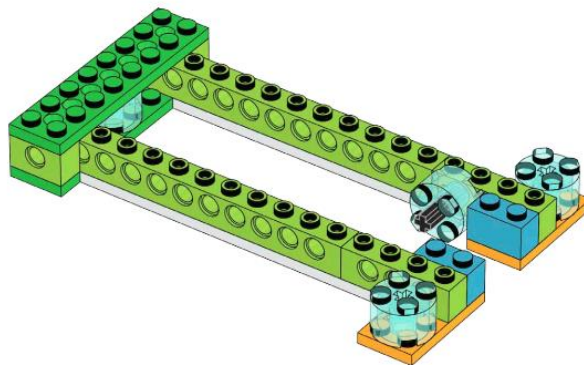

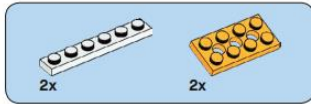

8

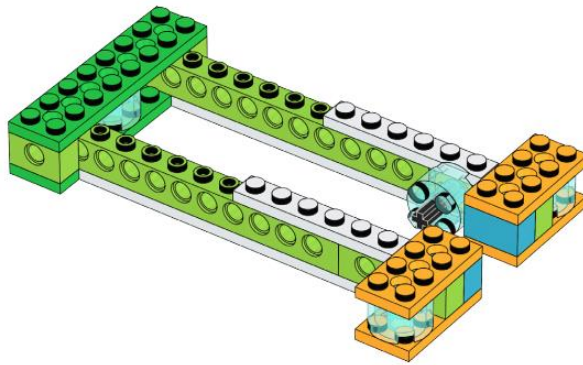

9

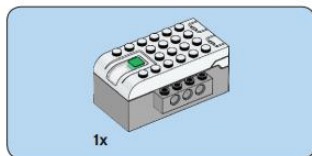
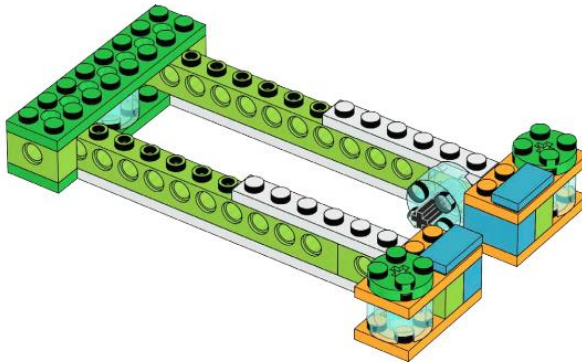

10

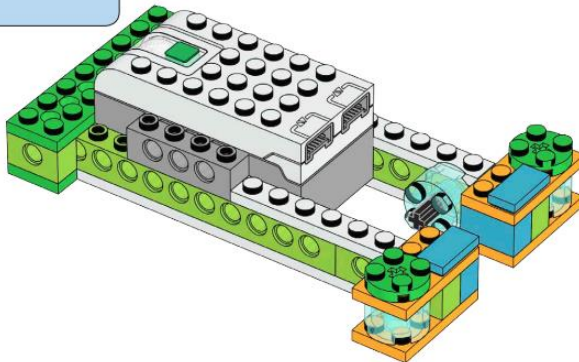

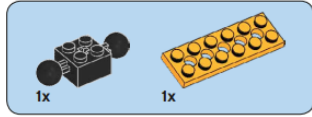

11

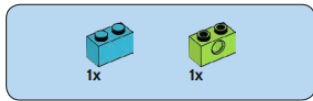
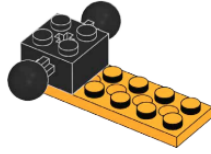

12

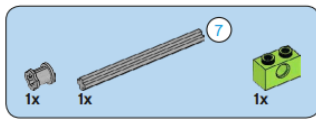
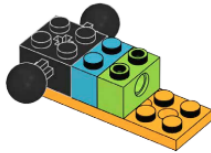

13

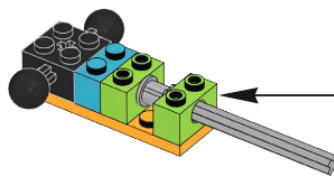
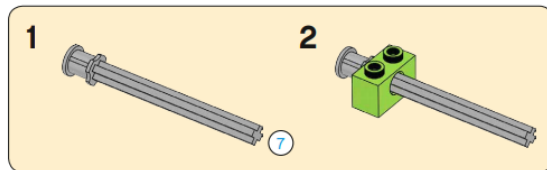

14

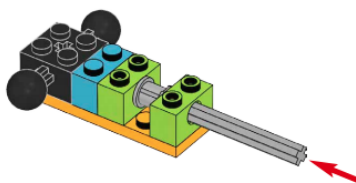

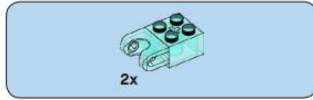

15

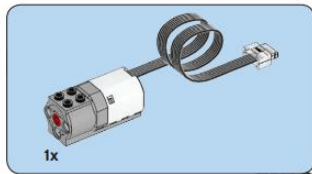
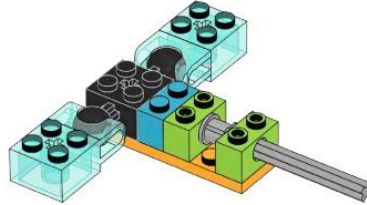

16

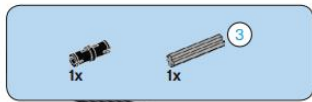
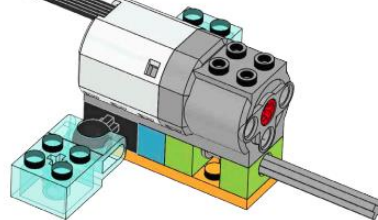

17

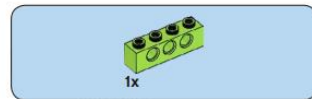
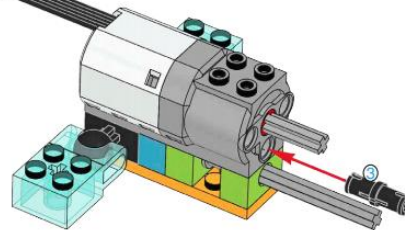

18

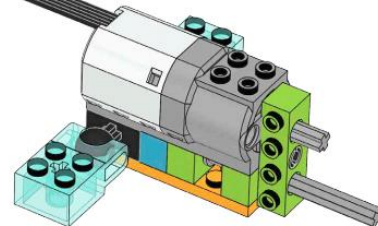

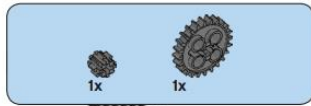

19

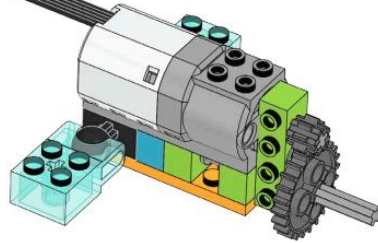

20

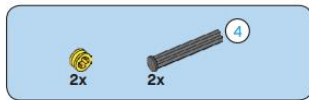
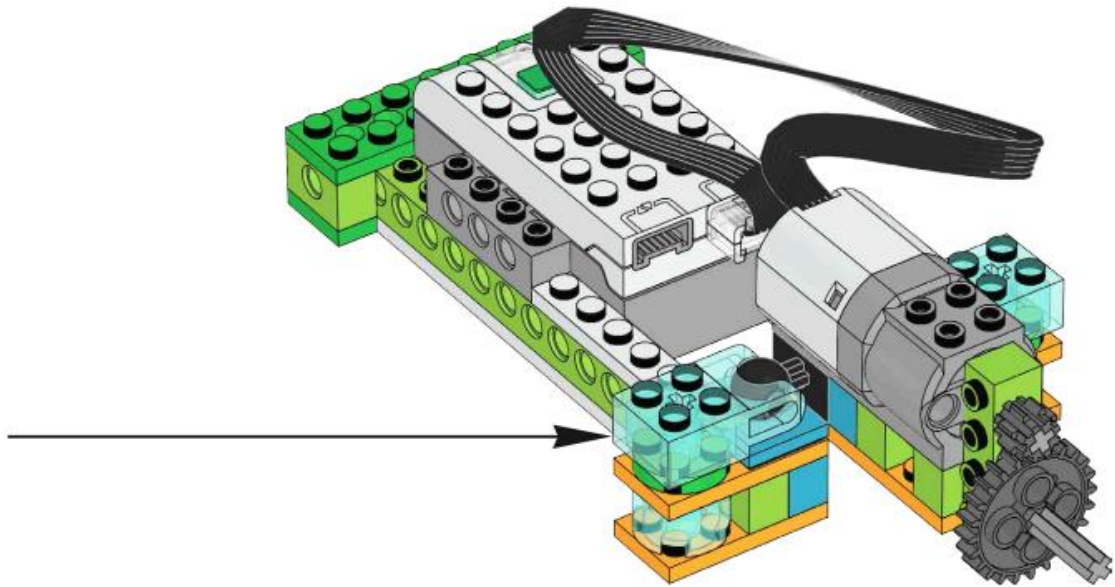

21

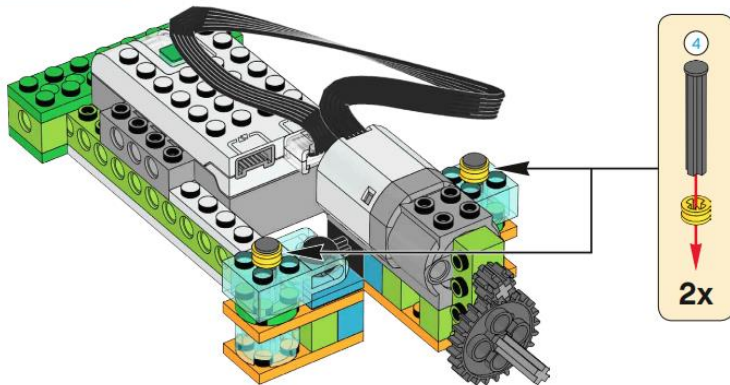

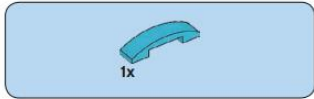

22

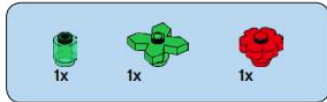
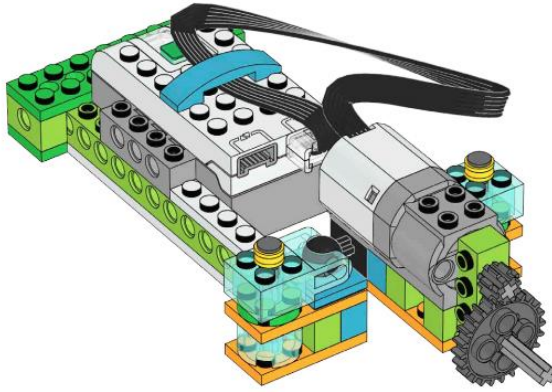

23

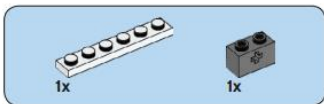
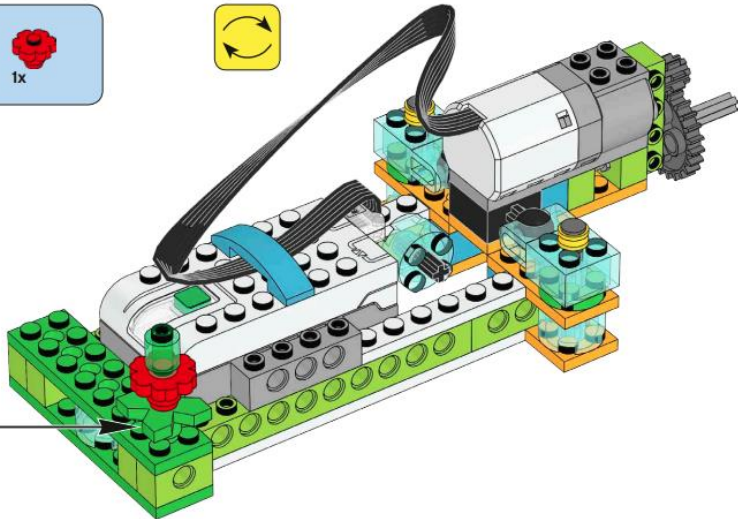
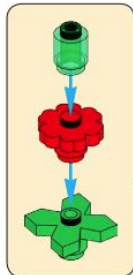

24

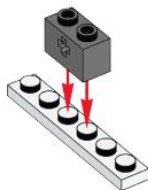

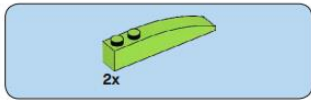

25

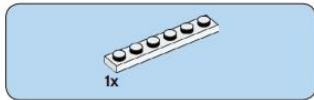
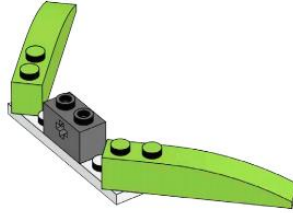

26

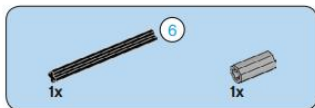
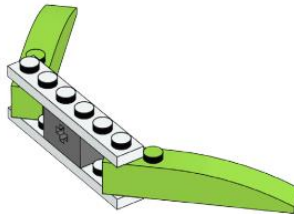

27

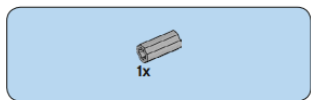
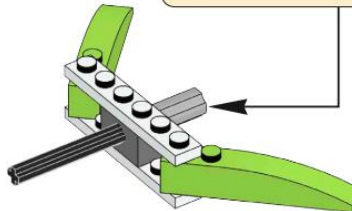
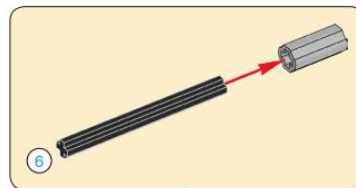

28

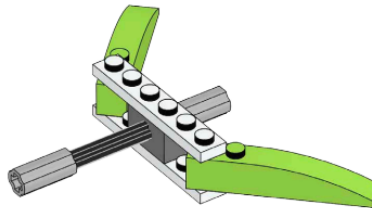

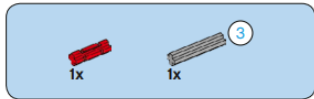

29

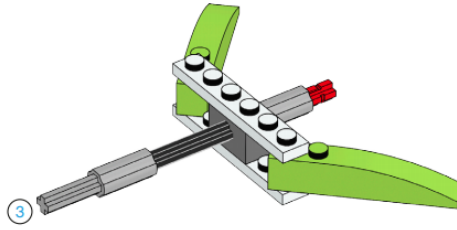

30

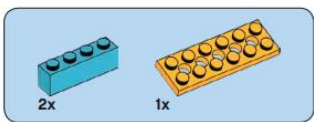
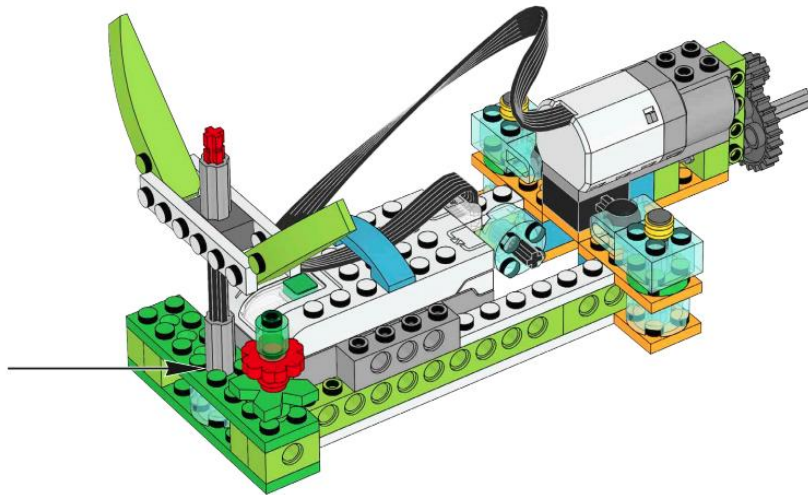

31

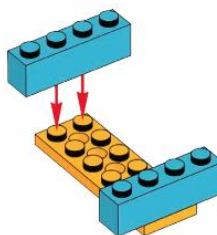



32

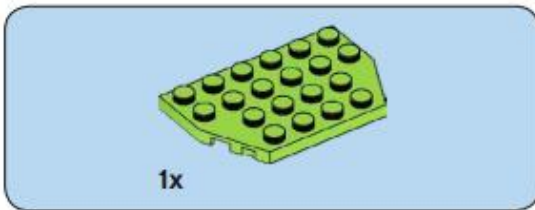
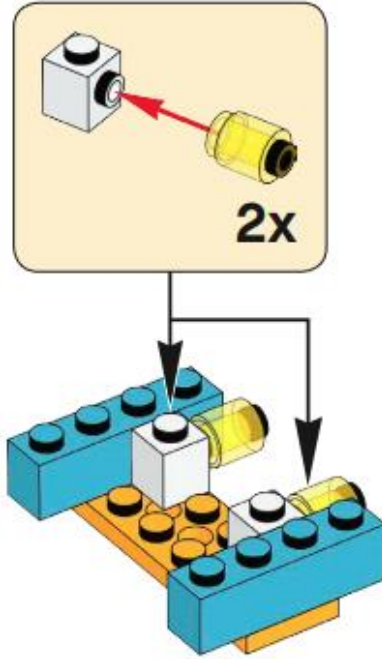

33

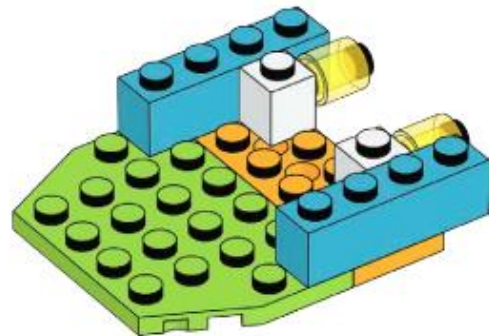

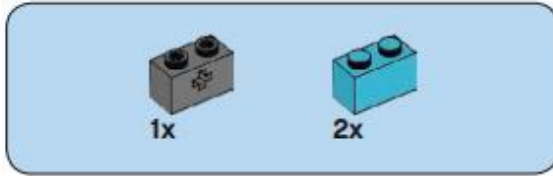

34

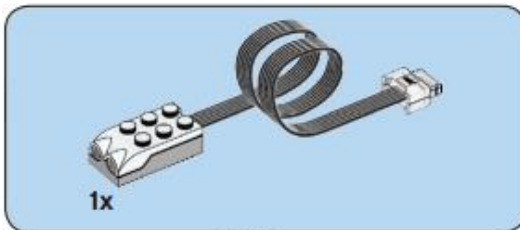
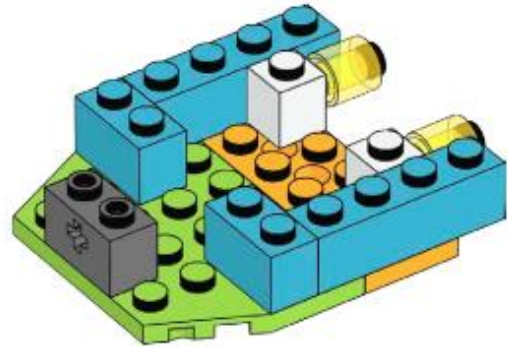

35

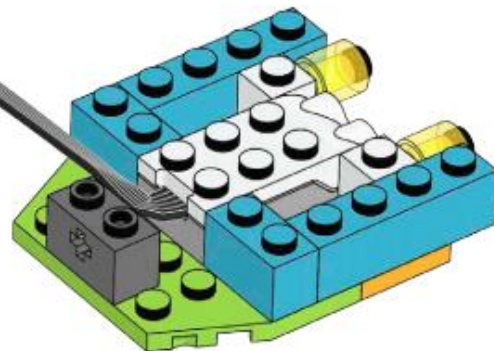

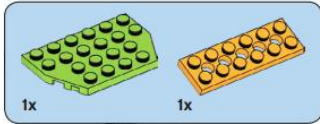

36

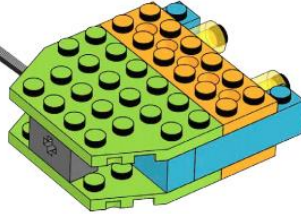

37

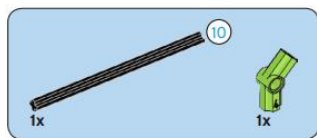
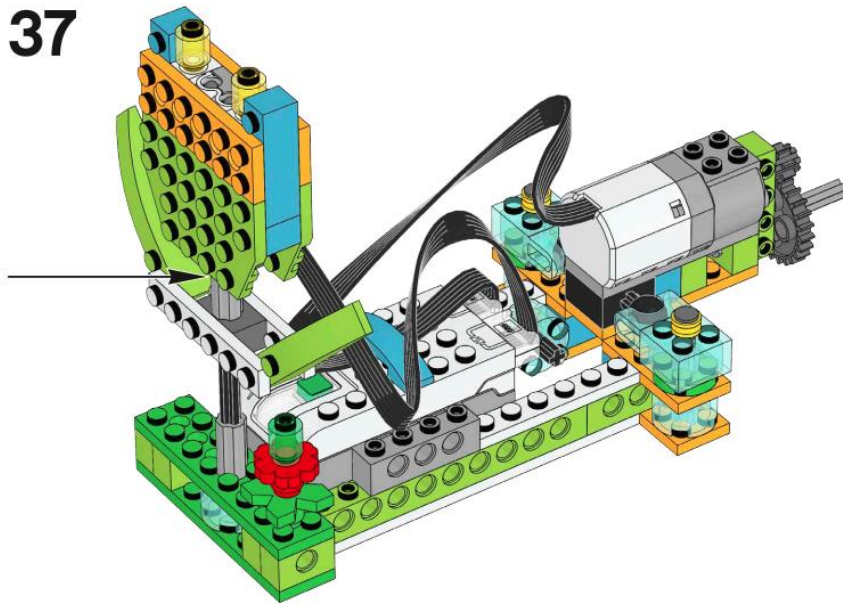

38



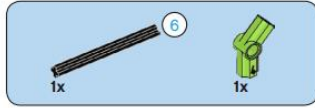

39



40

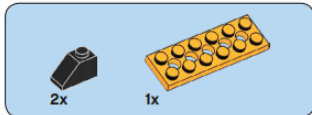
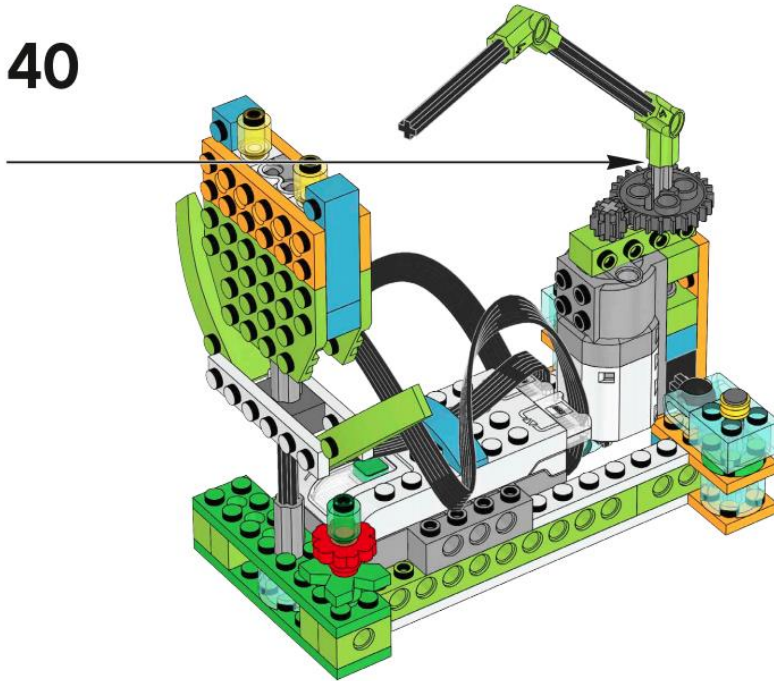

41

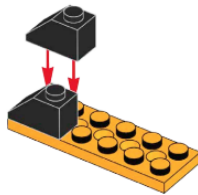

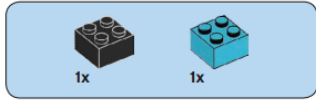

42

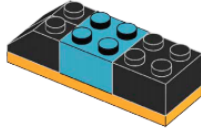

43

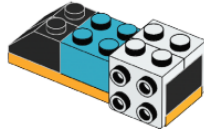

44

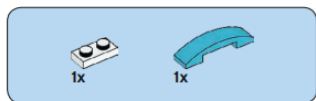
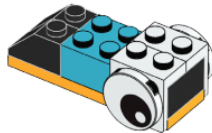

45

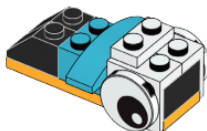

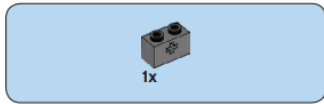

46

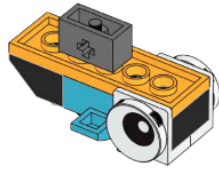

47

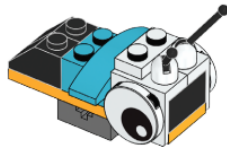

48

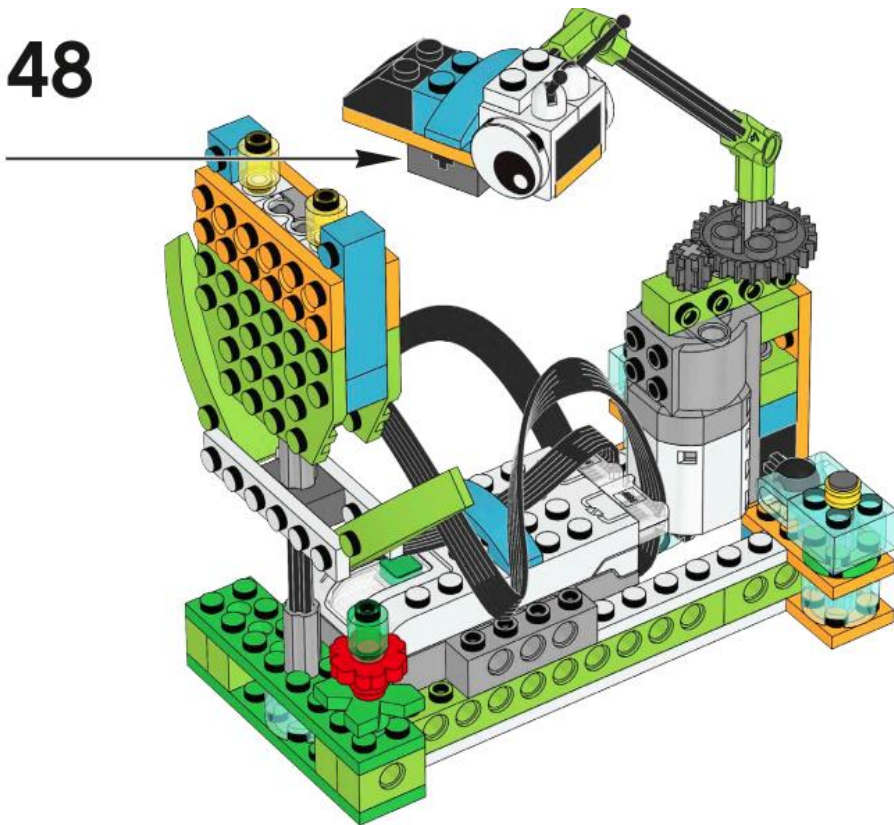

49

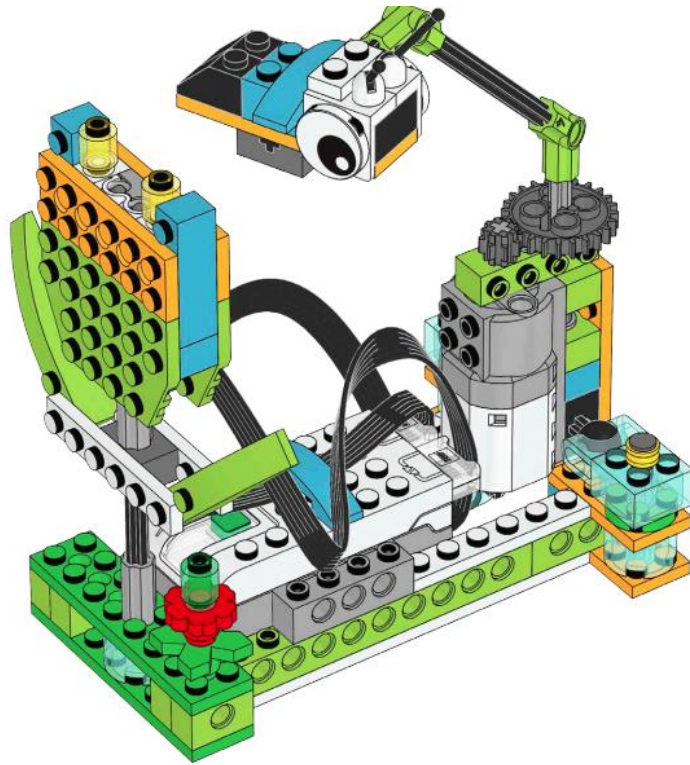

Codificación

```
al hacer clic en
  fijar potencia de motor a 10
  por siempre
    fijar dirección de motor a otro lado
    esperar hasta que distancia < 20
    iniciar sonido Crickets
    apagar motor
    esperar 4 segundos
    fijar potencia de motor a 10
```